

BEECHER 60" CAST IRON ROLL TOP TUB WITH 7" DECK HOLES

Cat. No.
CTR7H60



L: 60"
W: 30-1/8"
H: 22-3/4" (from floor to top of tub)
19-1/4" (from bottom of tub to top of tub)



The following is recommended for CTR7H60 tubs:

- Rim-mounted faucet: part #4601 or 4201
- Straight bath supplies: part #5577
- Leg tub drain: part #5599
- Complete shower unit: Part# 4045, 4062, or 4063

Gallon Capacity:	40
Shipping Weight:	500 lbs.
Empty Weight:	287 lbs.
Filled Weight:	621 lbs.

Features:

- ▶ Inside finish is white enamel
- ▶ Cast iron ball and claw feet
- ▶ Tub exterior is white (epoxy)
- ▶ 7" centers in tub deck
- ▶ Non-skid strips
- ▶ Feet are attached and leveled before shipment
- ▶ Tub is thoroughly inspected before shipment

Foot Finishes:

UF Unfinished
BL Painted Black
BQ Painted Bisque
PB Polished Brass



CP Polished Chrome
WH Painted White
PN Polished Nickel
SN Brushed Nickel
ORB Oil Rubbed Bronze

Custom Colors Available (inside of tub is always white enamel):
Painted bathtubs are considered "special order" and are not returnable
\$160 Bisque or Black \$250 Designer Color

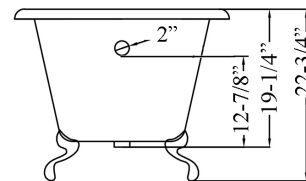
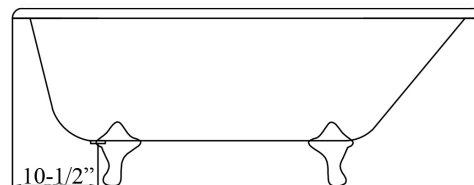
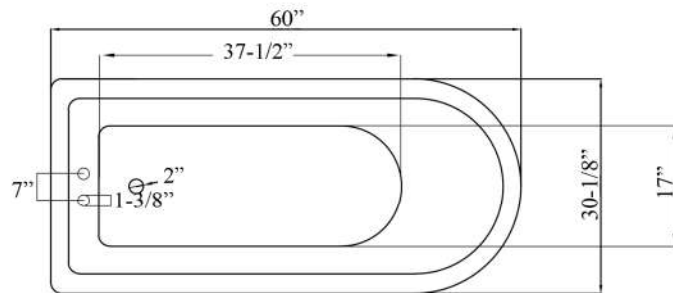

TUB WALL MOUNT FILLER WITH HANDSHOWER

Cat. No.
4602



Adjustable Swivel Mounts

Features:

- ▶ Brass construction
- ▶ Elephant spout length is 5-³/₄"
- ▶ Flow rate is 3.7 GPM
- ▶ Available with porcelain lever (**4602-PL**) or metal cross handles (**4602-MC**)
- ▶ Telephone handshower with cradle and hose
- ▶ Handshower flow rate 2.5 GPM
- ▶ Handshower includes backflow preventer
- ▶ Swivel mounts adjust centers from 3" to 12"
- ▶ Faucet centers are 7" without swivel mounts
- ▶ For tub wall mount installation
- ▶ ¼ turn ceramic disc cartridges
- ▶ IAPMO approved
- ▶ To be used with double offset bath supplies, **Part #5576**
- ▶ This faucet can also be used with rigid freestanding supplies, **Part #4502** with adjustable swivel mounts removed



Finishes:

BP Polished Brass
CP Polished Chrome
ORB Oil Rubbed Bronze

SN Brushed Nickel
PN Polished Nickel

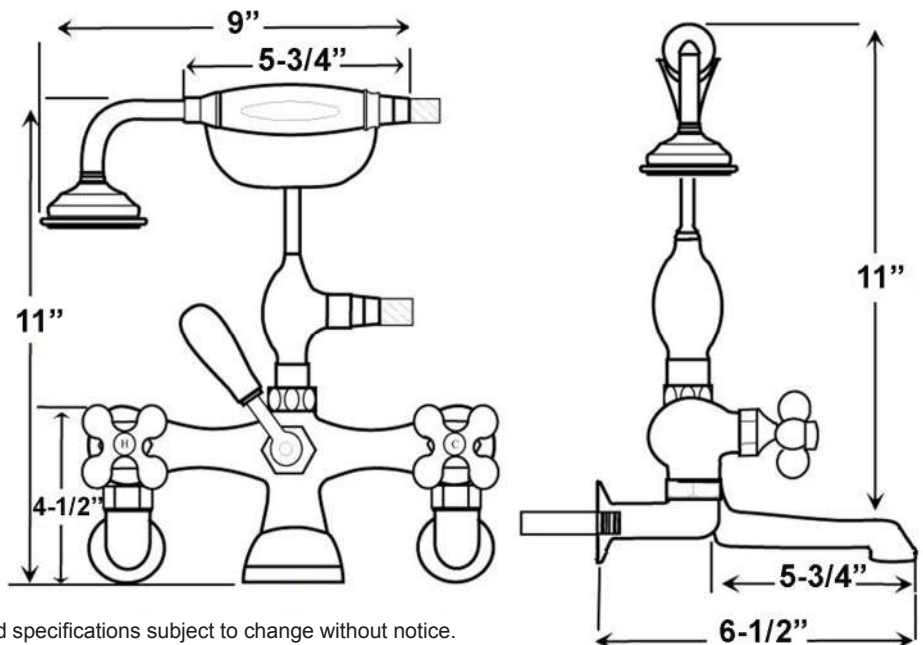
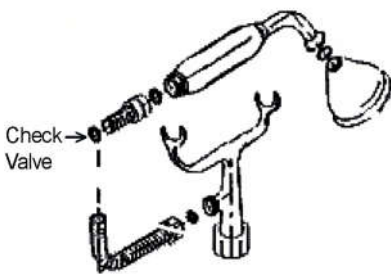

Dimensions are nominal and may vary. Dimensions and specifications subject to change without notice.

STRAIGHT BATH SUPPLIES

Cat.No.

5577



H: 24"

OD: 1/2"

Interior Dimensions:

Basin Interior: 13" x 11 7/8"

Basin Depth: 7 1/2"

Mount bolts height: 30"

Mount holes cc: 6"

Spout hole: 1 3/8"

Features:

- ▶ For use with faucets mounted to the tub deck
- ▶ No stops
- ▶ 1/2" Compression inlet
- ▶ 3/4" Compression outlet
- ▶ Bottom flange 2-1/2" diameter
- ▶ 0.500" Outer diameter
- ▶ 0.400" Inner diameter
- ▶ 0.030" Thickness of the wall
- ▶ Available in 5 Finishes

Compliance Certification

Meets or exceeds the following specifications: ASME-A112 (and 19.6M) for Vitreous china fixtures. ASME 112.19.9M for fire clay fixtures.

Finishes:

- CP Polished Chrome
- SN Brushed Nickel
- BP Polished Brass
- ORB Oil Rubbed Bronze
- PN Polished Nickel

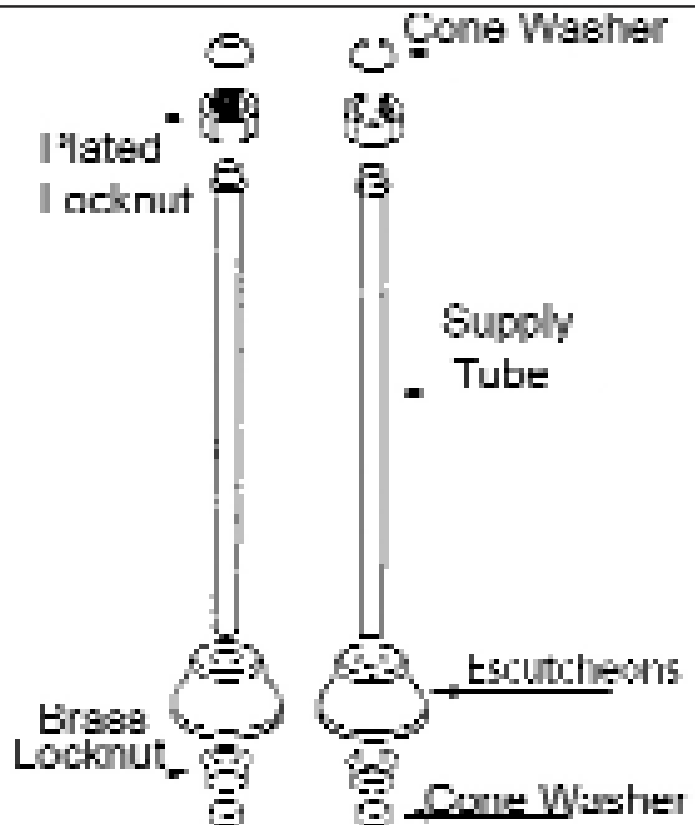

Use on concrete floors requires special installation. We recommend using a plumbing professional.

Dimensions and specifications subject to change without notice.

LEG TUB DRAIN

Cat. No.
5599



Escutcheon Height: 1-1/4"

Features:

- ▶ Twist-and-lift stopper
- ▶ Includes deep escutcheon
- ▶ Height adjustable 15"-18"
- ▶ Depth adjustable 12"-14"
- ▶ Includes deep escutcheon
- ▶ IAPMO approved
- ▶ Available in 5 Finishes

Finishes:

- CP** Polished Chrome
- BP** Polished Brass
- SN** Brushed Nickel
- PN** Polished Nickel
- ORB** Oil Rubbed Bronze

#5599 Leg Tub Drain



Dimensions and specifications subject to change without notice.

"D" SHAPED SHOWER ROD

Cat. No.
4145



"D" Rod Loop Connector



Rectangular Flange

Features:

- ▶ 1" Solid brass tubing
- ▶ Includes rectangular flanges(#300)
- ▶ Includes two "D" rod loop connectors (#331)
- ▶ Available In 3 Sizes: 48", 54", and 60"
(#4145-48, #4145-54, and #4145-60)
- ▶ All rods come as four pieces
- ▶ Ceiling Supports Available (#340)
- ▶ Available in 5 finishes

Finishes:

CP Polished Chrome
SN Brushed Nickel
BP Polished Brass
ORB Oil Rubbed Bronze
PN Polished Nickel

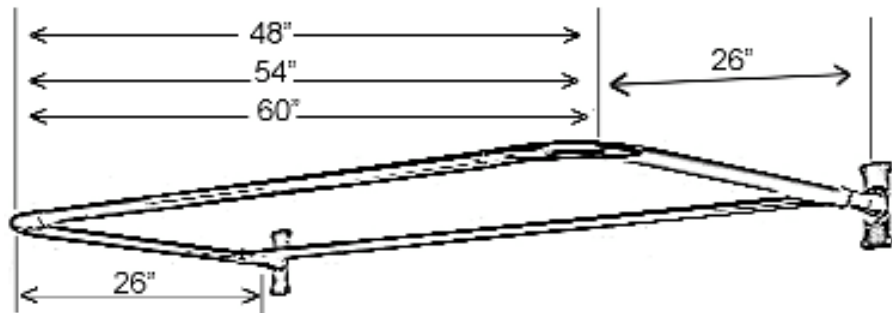

**Measurements Show Different
Lengths For Each Size Rod.**

Dimensions are nominal and may vary. Dimensions and specifications are subject to change without notice.